



Siemens PLM Software

What's new in Solid Edge ST8

Design without boundaries

Benefits

- Design more intuitively and efficiently - focus more on design and less on software
- Design anywhere with the best CAD experience on a mobile device
- Select from many flexible purchasing options
- Maximize productivity with individually tailored learning
- Access informative and dynamic user forums from the product window

Summary

Solid Edge® ST8 software from Siemens PLM Software delivers uniquely powerful modeling with unparalleled mobile flexibility and real-time access to a vibrant global user community that enables you to design without boundaries.

- Design the way you want to. Realistically. Accurately. Faster. Flexible modeling incorporating synchronous technology frees you to intuitively produce realistic, accurate designs faster, reducing time-to-market and product development costs.
- Solve design issues anywhere, anytime with modeling and viewing solutions that are optimized for mobile devices.
- Extend the power through partner-created apps, instantly available on the online Solid Edge App Marketplace.
- Work local while reaching the world with real-time access to Solid Edge Community and Facebook sites.

While there are hundreds of customer enhancements in Solid Edge ST8, the key innovations that will help you overcome the traditional constraints and boundaries of product modeling are highlighted below.

Uniquely powerful

More intuitive and flexible 3D modeling tools, facilitated electrical routing, enhanced design documentation capabilities and visual design management innovations in Solid Edge SP ST8 design

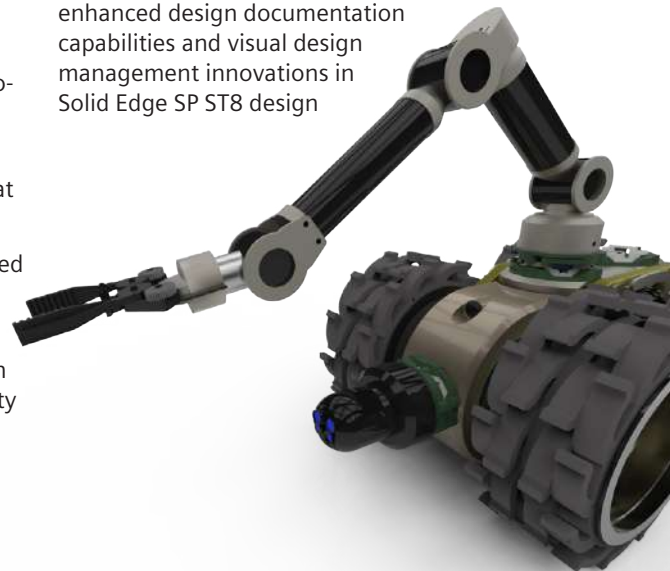

What's new in Solid Edge ST8

Features

- Fully functional design sessions on the Microsoft Surface™ Pro 3 tablet
- Free mobile viewing app for Windows® 8.1
- Intuitive control of synchronous modeling
- Streamlined component design within large assemblies speeds project completion
- Precise control of component position, spacing and orientation along any curve
- PMI persistence and intelligent wire path definition facilitate electrical routing
- Easy drawing revision comparisons shorten the time between design and production
- Expanded visual design management capabilities
- Comprehensive resources within the Learning Portal shorten learning curve
- Live feed of Solid Edge Community connects local and global users

management solution enable users to focus more on their designs and less on the tool. The ability to accurately simulate a product's operating conditions reduces the need for physical prototypes and ultimately results in an accelerated modeling process and shorter time-to-market.

Intuitive design powered by synchronous technology

Synchronous modeling is even more intuitive, with a streamlined interface that displays only relevant intent. As you make quick edits to the model, you will be presented with just the information which directly impacts the modification - allowing you to concentrate on your design.

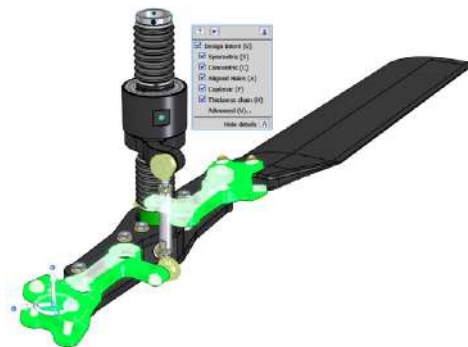

Flexible patterning

Extending the recognition of hole patterns within imported geometry, Solid Edge now recognizes regular repetition of any geometry as a circular, rectangular, or even user-defined pattern. Also, geometry can be patterned in irregular arrays.



Helical curve

Helical or spiral curves can be created and driven by keypoints or cylindrical and conical geometry. Various pitch types greatly simplify downstream construction of complex surfaces and tubing.



Advanced weldment design

Weld beads, applied within one assembly, can be captured as part files and applied to alternate assemblies, no matter the orientation – a huge benefit for machinery designs requiring extensive welding.



Design-in-context

Design of complex assemblies is simplified by the ability to locate geometry from upper-level components while editing in-place parts or subassemblies. Also, interpart links can be created without write access to the upper-level assembly, enabling faster completion of design projects.

Realistic drive system modeling

Accurate, more realistic simulation of chain drive and track motion is achieved via the

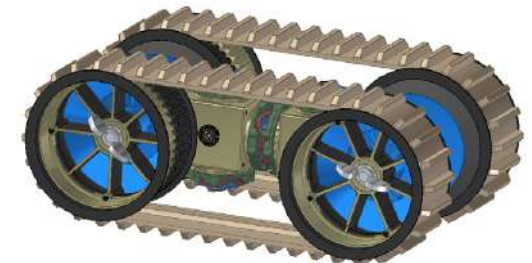

new Path relationship, which provides precise positional control of components along

a curve. Also, you can pattern those components along the curve, controlling spacing and orientation as needed – a very useful capability for machinery design.

Mechanism modeling

Subassemblies can now impose motion on surrounding components and move in response to external drivers, resulting in accurate simulation of mechanism motion, further reducing the need for physical prototypes.

PMI-powered wire harness routing

Terminal and connector designations and pin names are defined as persistent product and manufacturing information (PMI), linking electronic computer-aided design (ECAD) intelligence with physical geometry while routing, and providing a significant wire routing productivity gain.

Speedy and intuitive routing

Wire routing workflow enhancements permit paths to be split at a splice point, and information can be attributed to the wires flowing from that point. Also, paths will automatically route through keypoints of a part, making quick work of clip assignment. And now a single path can carry multiple bundles, greatly increasing routing productivity.

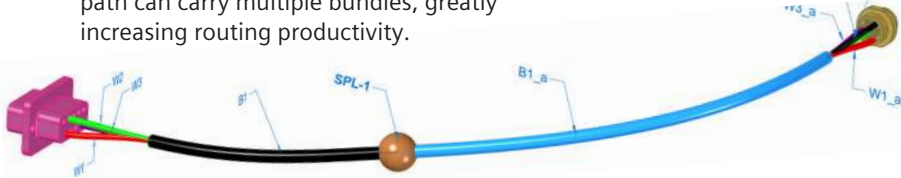

Efficient revision comparison

Easily identify differences between drawing revisions created in Solid Edge, cutting the time between development and manufacturing.

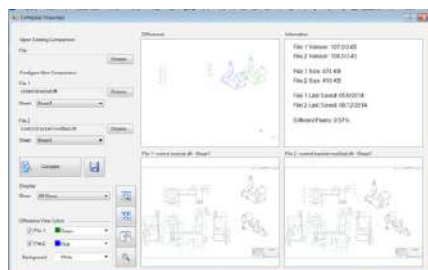

Flexible parts lists

Build a list of item numbers specific to a selected portion of a large product structure, excluding all other components.

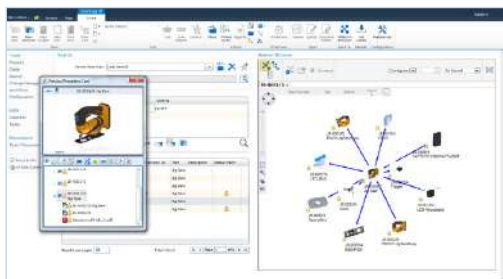
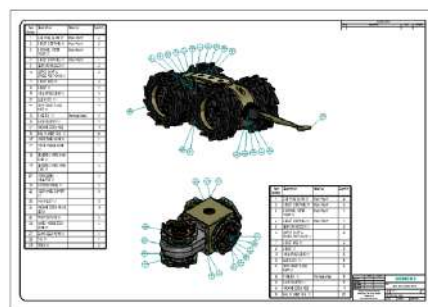

Windows-style organization

Improved capabilities for design management in Solid Edge SP ST8 enable users to understand all the data involved in complex design projects, complete engineering changes faster and improve their overall productivity for design project completion. Move multiple documents in an Item Master structure as you would files in Windows – select the items, identify the destination and continue working while the server does all the work.

Quicker access to design data

Accelerated data searches quickly and easily expose lists of vendors, work areas, materials, and classifications, as well as costs, manufacturing times and associated actions.

Easily link designs and projects

Create and link ECRs, ECOs, Projects and Carts to your parts as you work.

Automate common tasks

New capabilities speed the creation of ECRs, ECOs and release-to-manufacturing workflows. Easier assignment of reviewers and approvers for specific workflows and automated creation of output files including PDF documents, DXF and Viewer files during release.

Accessibility unleashed

No longer tethered to the desk, designers have complete freedom to create and modify their designs anywhere and at any time, improving responsiveness and increasing customer satisfaction.

Solid Edge on Microsoft Surface Pro 3

Run full Solid Edge design sessions on this lightweight, highly portable platform. The Solid Edge user interface has been optimized to use finger gestures on the touch screen for view manipulation, and the Surface Pen for more accurate input for sketching and geometry selection operations for an intuitive, highly productive user experience.



Design collaboration on the go

Supplementing existing offerings for iOS and Android, the free Solid Edge Viewer app on Windows 8.1 extends state-of-the-art 3D design collaboration to Microsoft's Surface Pro tablets.



Easier access to best-in-class design technology

Use professional 3D CAD on flexible, short-term commitments: Solid Edge is available via affordable monthly subscriptions across the globe, providing both small firms and large corporations the flexibility to quickly react to fluctuations in demand and market forces while managing costs.



Amazing user experience

An unparalleled learning experience

The Solid Edge Learning Portal provides a comprehensive collection of resources determined to quickly advance your knowledge. Learning paths tailored to your experience level utilize instructional videos, step-by-step activities and self-paced and instructor-led course materials to maximize your productivity.

Work local, while reaching the world

Users now have the opportunity to share with other global users as well as Solid Edge personnel via real-time access to the dynamic Solid Edge Community and Facebook forums from within Solid Edge.

Contact
Siemens PLM Software
Americas +1 314-264-8499
Europe +44 (0) 1276 413200
Asia-Pacific +852 2230 3308

www.siemens.com/plm

© 2015 Siemens Product Lifecycle Management Software Inc. Siemens and the Siemens logo are registered trademarks of Siemens AG. D-Cubed, Femap, Fibersim, Geolus, GO PLM, I-deas, JT, NX, Parasolid, Solid Edge, Syncrofit, Teamcenter and Tecnomatix are trademarks or registered trademarks of Siemens Product Lifecycle Management Software Inc. or its subsidiaries in the United States and in other countries. All other logos, trademarks, registered trademarks or service marks belong to their respective holders.
45216-Y7 4/15 A